

# LANE TECH SHEET

## 3 STEP POLY LADDER

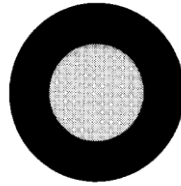

RAIL  
9/16" Grade 60 Round Bar

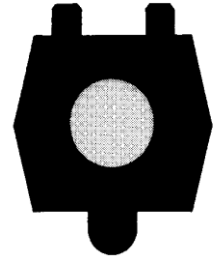

RUNG  
1/2" Grade 60 Rebar

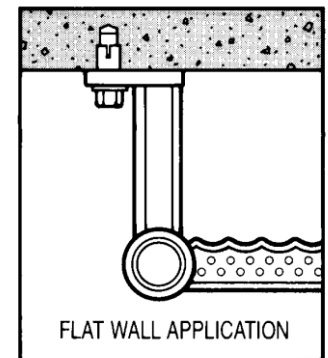
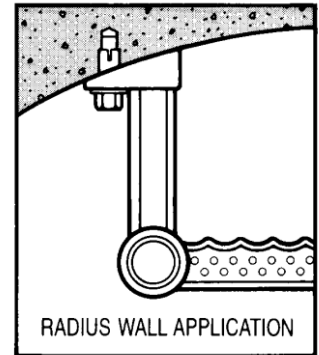
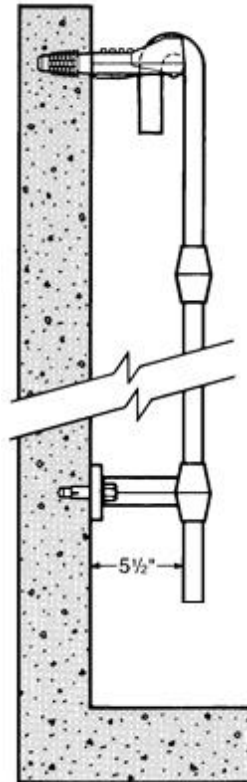
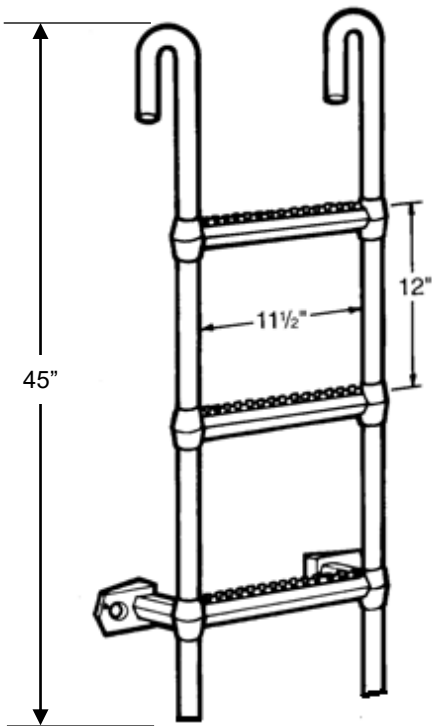

Polypropylene conforms to ASTM D-4101.  
Ladders meet all ASTM C-497 load requirements.

Ladders to be fastened to wall with 1/2" x 2-3/4" wall anchors

Drawing: 1  
Scale: None

3 Step Poly  
Hanging Ladder  
Part # PL-3

**LANE** INTERNATIONAL CORPORATION

P.O. Box 925 \* Tualatin, OR 98062  
503-692-9860 \* [www.laneinternational.com](http://www.laneinternational.com)